

# Charged Particle Emissions in Metal Deuterides Upon e-Beam Excitation of Their Deuterium Subsystem



Andrei Lipson<sup>1</sup>, Ivan Chernov<sup>2</sup>, Alexei Roussetski<sup>3</sup>,  
Aslan Tsivadze<sup>1</sup>, Yuri Cherdantsev<sup>2</sup>, Boris Lyakhov<sup>1</sup>,  
Eugeniy Saunin<sup>1</sup> and Michael Melich<sup>4</sup>

<sup>1</sup>A.N. Frumkin Institute of Physical Chemistry and Electrochemistry,  
Russian Academy of Sciences, Moscow 199915, Russia

<sup>2</sup>Tomsk Polytechnic University, Tomsk, 634050 Russia

<sup>3</sup>P.N. Lebedev Physics Institute, Russian Academy of Sciences, Moscow,  
119991 Russia

<sup>4</sup>Naval Postgraduate School, Monterey CA 93943 -5000 USA



# Introduction

---

- Recent *ab-initio* study of hydrogen desorption from metal hydrides with a high hydrogen solubility [V.M., Silkin, I.P Chernov et. al, Phys. Rev., B **76**, 245105 (2007)], showed that excitation of the hydrogen subsystem in those deuterides results in plasmon formation leading to generation of strong electric fields ( $F \sim 10^8$  V/cm) within at a lattice parameter scale ( $a \sim 0.3-0.4$  nm). As a result, the mean energy of desorbed protons/deuterons ( $E_d$ ) escaping from the hydride surface would effectively be increased from  $kT \sim 1/40$  eV to several eV ( $E_d = F \times a \sim 3-4$  eV) or two orders of magnitude increase, effectively producing “hot” deuterons
- Such deuteron acceleration mechanisms, along with possible large electron screening in the metal targets with enhanced hydrogen diffusivity, could potentially greatly enhance the yield of the DD-reaction in metal deuterides, even at extremely low energy of excitation.



# Objectives

---

- To verify the hypothesis on the role of external beam excitation of the hydrogen subsystem in metal deuterides enhances charged DD product yield.
- To establish presence of energetic alpha-particle emission under e-beam irradiation.
- To test new triple/5 CR-39 detector configuration in vacuum experiments, improving charged particle identification.



## Experimental: Set up

---

- A set of 3-5 plastic track (noiseless) CR-39 detectors has been used while the deuterated samples are exposed to an electron beam excitation.
- Three CR-39 detectors, covered with Al and Cu foils with known stopping ranges, can be considered as the simplest dE-E detector but without time dependence determination.
- The Foreground counts are the tracks observed on CR-39 surface facing the sample, while the Background counts arise from the CR-39 facing away from the sample, that is, facing the vacuum chamber or the stainless support.

The sample-detector holder assembly that is mounted in the SEM vacuum chamber ( $p = 10^{-6}$  torr) and irradiated by a collimated electron beam of the EDS electron gun ( $J = 100\text{-}300$  nA,  $E = 30$  keV). The desorbed deuterium and generated charged particles reach the detectors from the spot where the e-beam impinges with dimensions  $S = 8 \times 6$  mm<sup>2</sup>. The effective distance between the center of the spot and the detectors 1 and 2 is about  $\langle R_{\text{eff}} \rangle = 12$  mm.

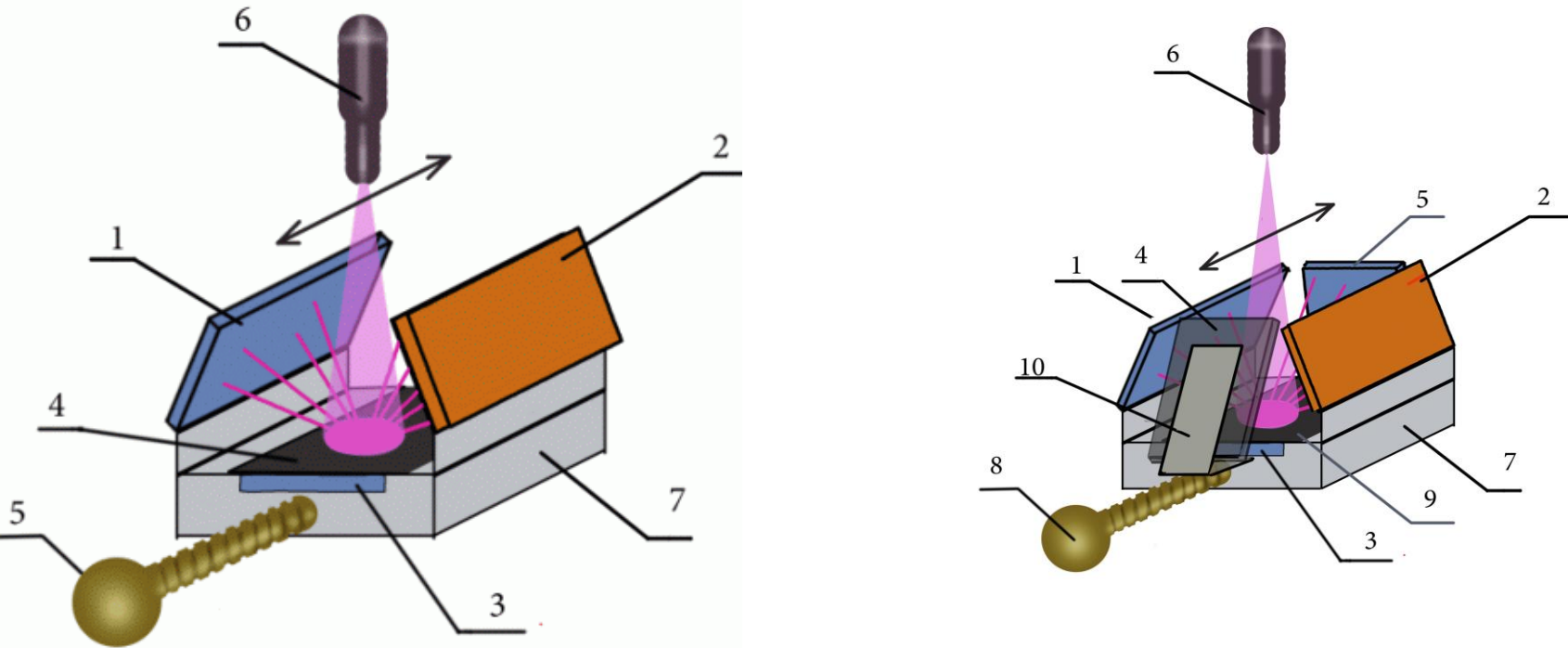

1,2 and 3 – are the CR-39 detectors covered with the 11  $\mu\text{m}$  Al (1), 25  $\mu\text{m}$  Cu (2) and 33  $\mu\text{m}$  Al (3) foils, respectively, 4 –deuterated sample, 5-manipulator, 6-electron gun, 7- stainless support

# Four-detector sample holder



ICCF-15, Rome. Italy 10/5-9,  
2009

SEM with sample holder inside (left); test of the e-beam position and size (8x6 mm<sup>2</sup>) using a luminophore plate at the sample position (right).



ICCF-15, Rome. Italy 10/5-9,  
2009

Vacuum Background: Traces of fast neutron irradiation (recoil protons) are found on both sides of the CR-39. These originated, apparently, during neutron beam scanning of the chips by airport NAA screening. (Peaks at 8.0 and 8.6 microns are consistent with alphas from Rn(U) and Th series). No peak is seen after subtraction of the rear side counts from the front side one.

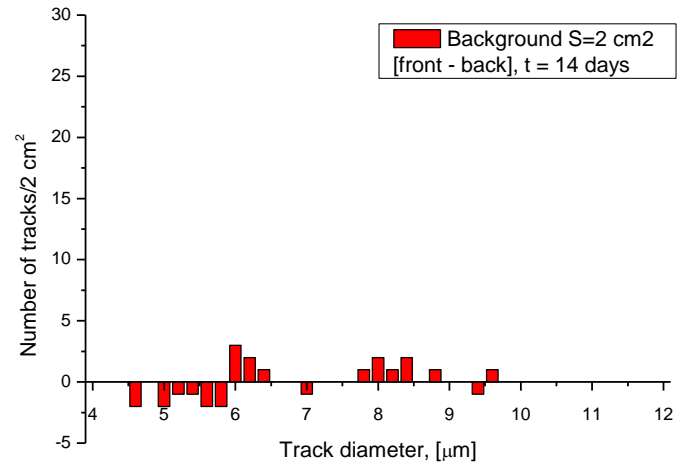
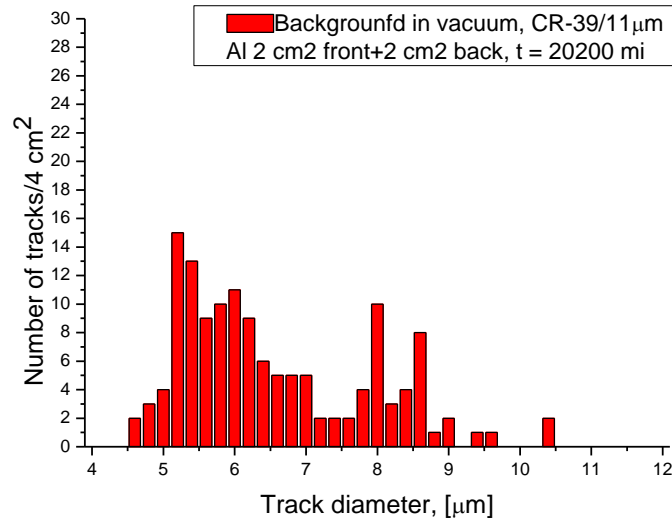

In the track diameter range of interest ( $4.0 < d < 8.0 \mu\text{m}$ )  $\langle N(\text{bg}) \rangle = 25 \pm 10$  track/cm<sup>2</sup> (normal Background is  $\sim 10$  track/cm<sup>2</sup>), Etch: 6N NaOH, 70 C, t=7.0 hr.



Calibration of the CR-39 in direct contact with the bottom of the sample in the sample. Tracks produced by a Pu-238 alpha source ( $E_{\alpha} = 5.5$  MeV) with diameter 6 mm has a detection efficiency of  $\varepsilon = 8.0$  %. Note that almost 60% of all tracks are of oblique incidence, in contrast to the other two detectors where the tracks have normal incidence.

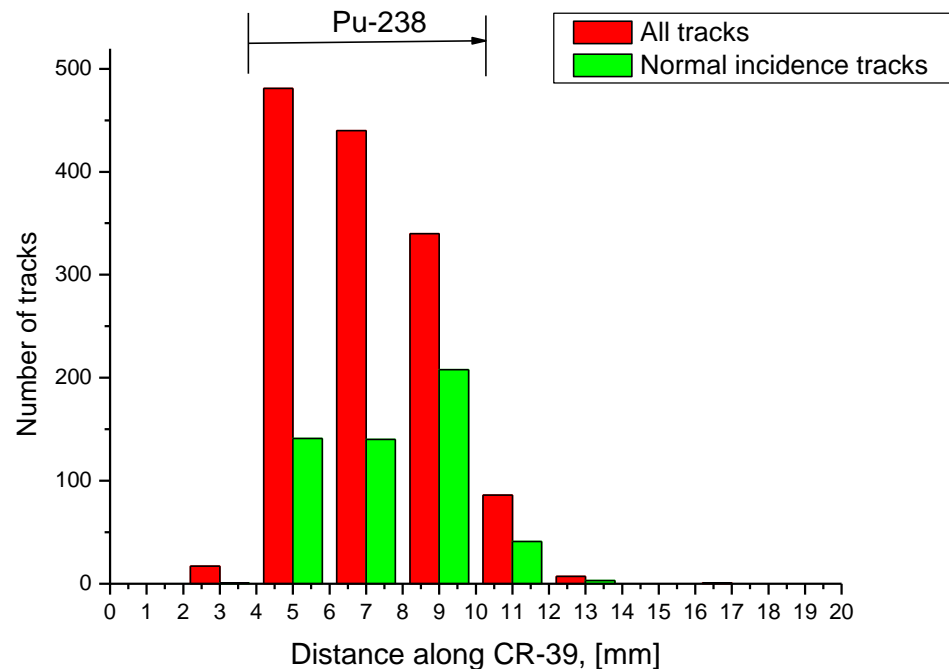

Calibration of detectors 1 and 2, placed along and over the sample, using an extended Pu-238 alpha source.

(detector efficiency  $\varepsilon = 2.6 \%$ , 87 % of the tracks are normally incident !)

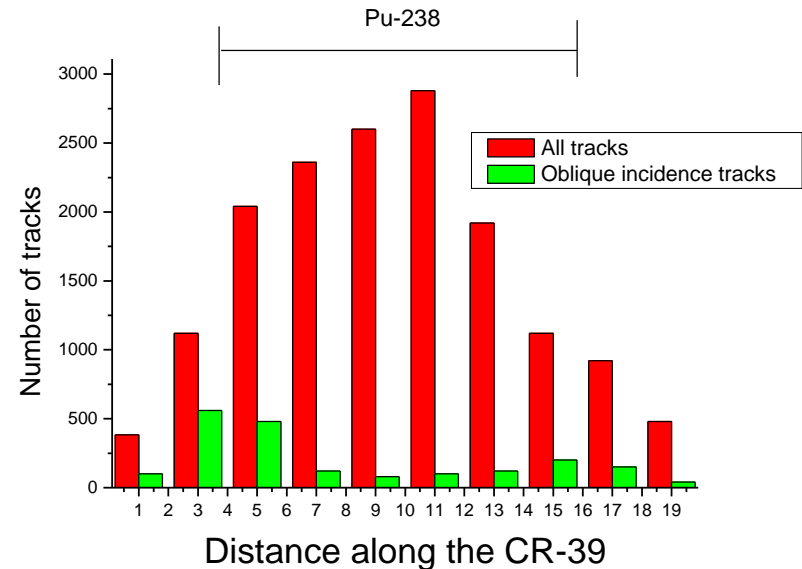
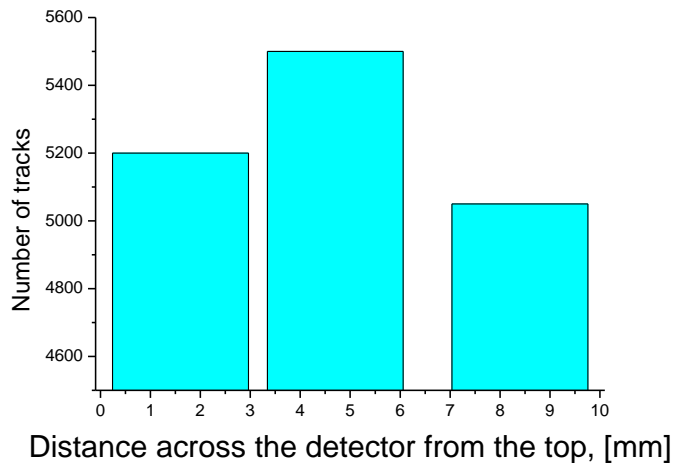



## Pd/PdO:Dx Sample preparation

---

- The PdO/Pd/PdO samples are prepared by thermal oxidation using Nilaco (Japan) Pd foil (99.95 % purity) of 50  $\mu\text{m}$  thick with dimensions  $S = 30 \times 10 \text{ mm}^2$ .
- Electrochemical cathode loading in 0.3M-LiOD solution in D<sub>2</sub>O with Pt anode;  $j = 10 \text{ mA/cm}^2$ ,  $T \sim 280 \text{ K}$  (Siberian room temperature) in special electrolytic cell with split cathode and anode spaces.  $x = \text{D/Pd} \sim 0.73$  (about 40 min required).
- The samples are rinsed in pure D<sub>2</sub>O and then placed in a glass Dewar to cool them to  $T = 77 \text{ K}$ .
- The cooled samples are then rapidly mounted (less than 1 min) in sample holder inside of CR-39 detectors array and irradiated by the e-beam ( $E = 30 \text{ keV}$ ,  $J = 0.2\text{-}0.6 \mu\text{A/cm}^2$ ).
- In reference experiments without the e-beam stimulation only two CR-39 detectors (one with no metal foil and one with 25  $\mu\text{m}$  Cu) were used.

Rutherford Back Scattering/ Elastic Recoil (RBS/ERD) scans of the Pd/PdO samples. Prior to D-loading –left; After electrochemical loading and D-desorption in vacuum during 50 min of e –beam ( $J=0.6 \mu\text{A}/\text{cm}^2$   $U = 30 \text{ kV}$ ) treatment - right

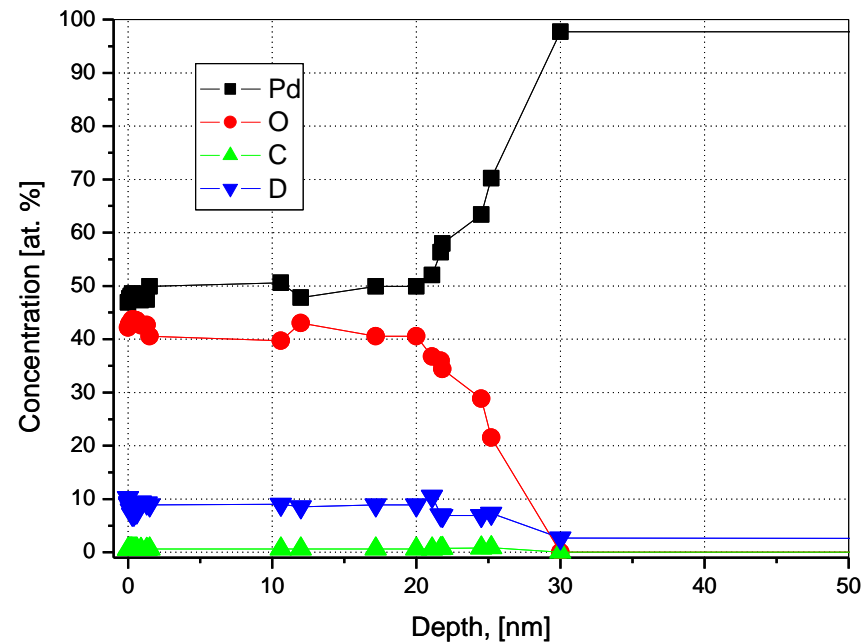
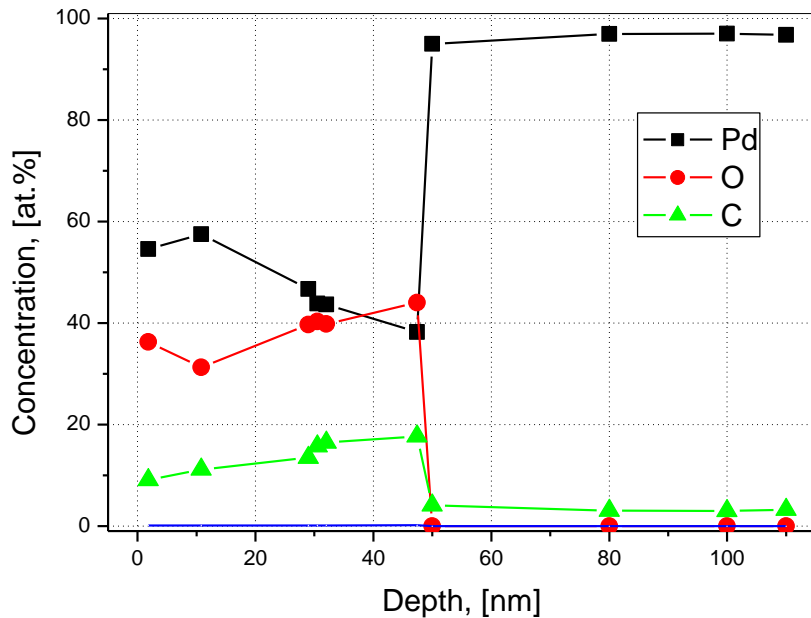

Fraction of D desorbed from the Pd/PdODx sample in vacuum without e-beam excitation and in air. With e-beam the desorption rate is  $J_D \sim 3.3 \times 10^{15}$  D/s-cm<sup>2</sup>. The number of desorbed deuterons is consistent with that achieved when D-desorption is done in air at ambient conditions. Note desorption is nearly absent in vacuum without stimulation.

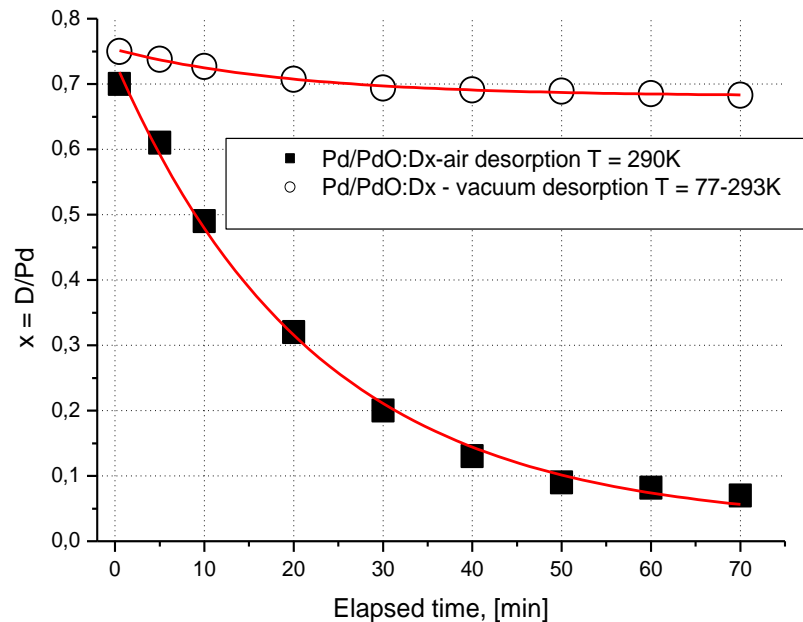

D-desorption rate from the Pd/PdO:Dx samples in vacuum (electrolysis at T=280 K with cooling down to T = 77K after electrolysis termination)) and in air at ambient conditions (electrolysis at T=290K).



## TiD<sub>x</sub> sample preparation

---

- Ti foils of 30 and 300 μm thickness have been electrolytically loaded. (1M solution D<sub>2</sub>SO<sub>4</sub> in D<sub>2</sub>O for 35 hrs,  $J = 30 \text{ mA/cm}^2$ , to achieve D-penetration.)
- The average loading ( $x = \text{D/Ti} = 0.1$  at depth of 2-3 μm), determined by weighing.
- The D-desorption rate in case of TiD<sub>x</sub> with e-beam stimulation is consistent with the  $J_D \sim 2.0 \times 10^{14} \text{ D/s-cm}^2$ .
- All desorbed deuterons in TiD are from the action of the e-beam because the compound is absolutely stable at  $T = 300 \text{ K}$ .

# RBS/ERD profiles of the TiDx samples prior to e-beam bombardment –left; after D-desorption in vacuum during 60 min of e –beam ( $J=0.6 \mu\text{A}/\text{cm}^2$ $U = 30 \text{ kV}$ ) treatment - right

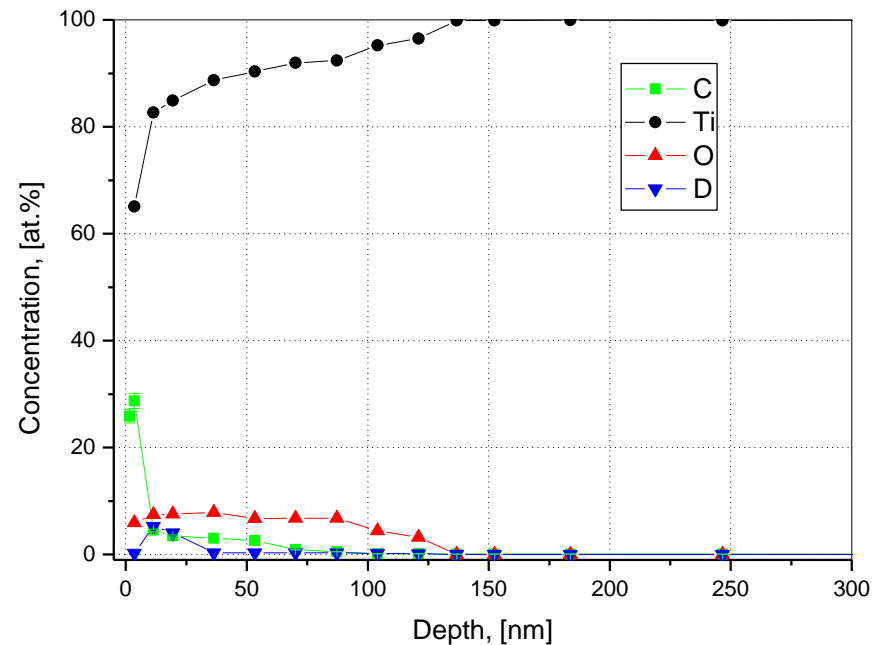
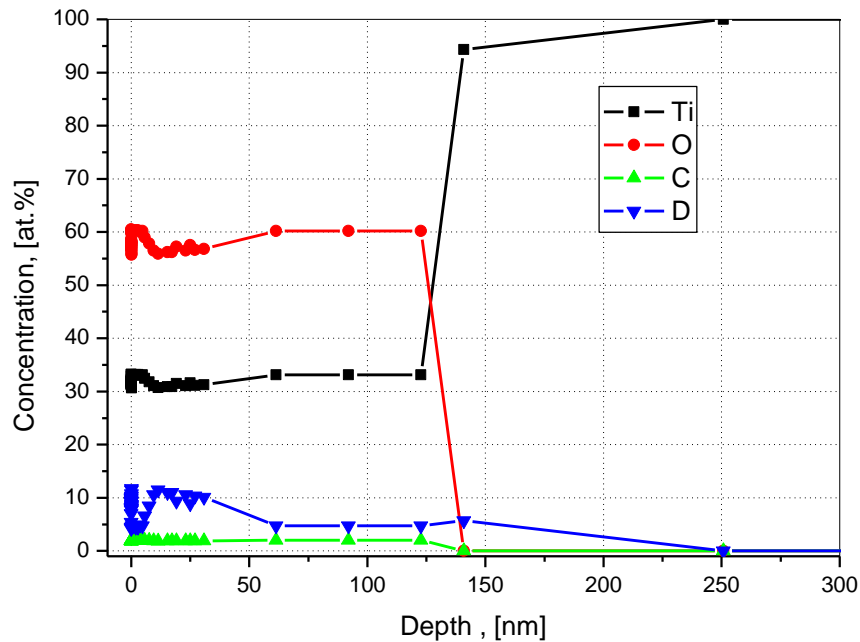

# Pd/PdO:D<sub>x</sub> without e-beam stimulation. No proton and alpha tracks seen. CR-39/11μm Al filter (4 samples, t = 3300 min)

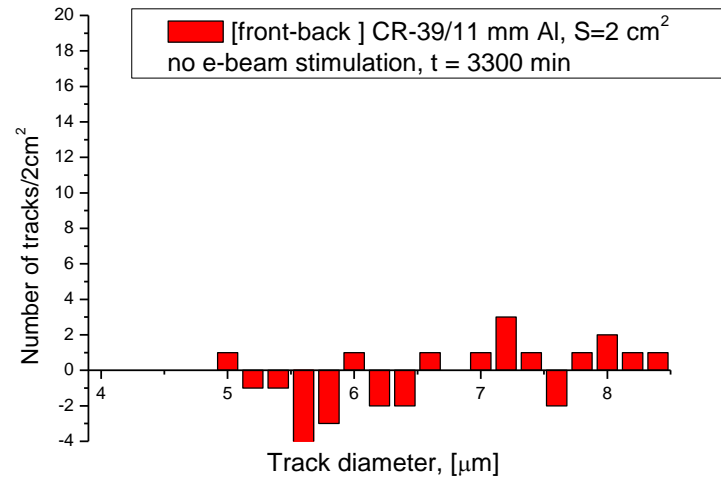
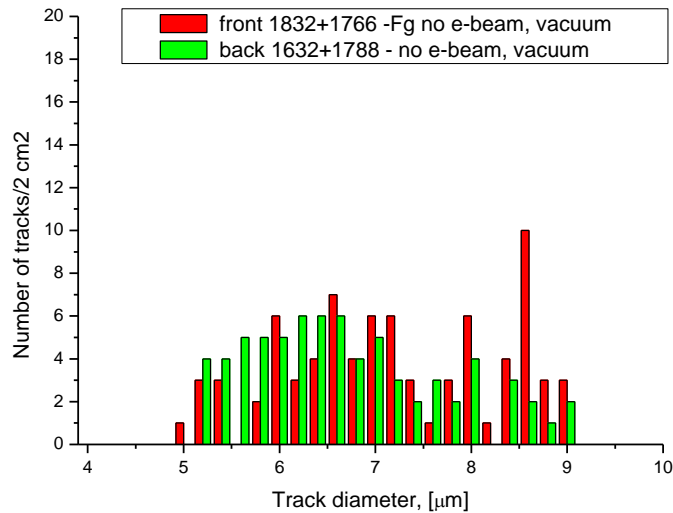



# Pd/PdO:D<sub>x</sub> without e-beam stimulation. No proton and alpha effect seen. 25 μm Cu covered CR-39 (4 samples, t = 3300 min)

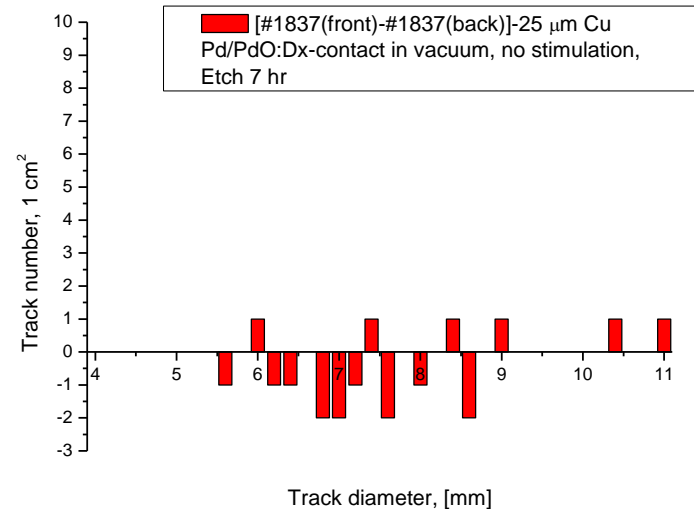
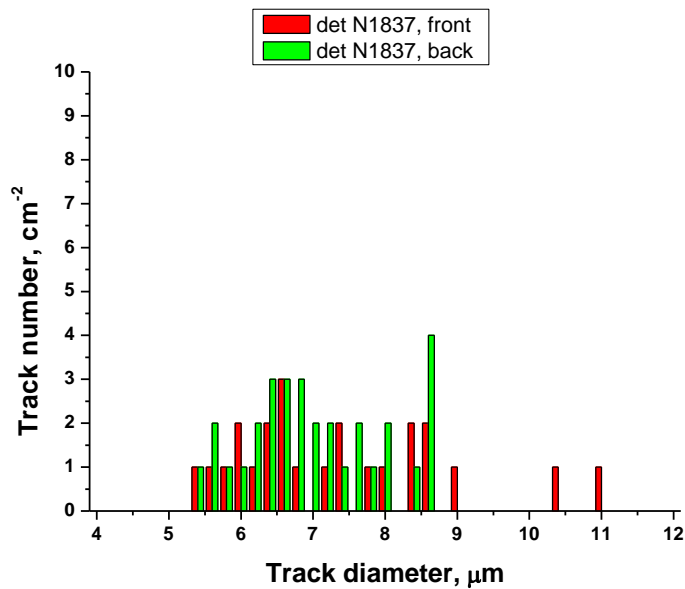

**Pd/PdO:D<sub>x</sub> with e-beam stimulation. Front side (Foreground) compared to the back side (Background). 11 μm Al – det. 1 (left), 25 μm Cu- det.2 (right) filters. Total 66 runs of 50 min each, 4 series summary, S=4 cm<sup>2</sup>, Στ = 3300 min**

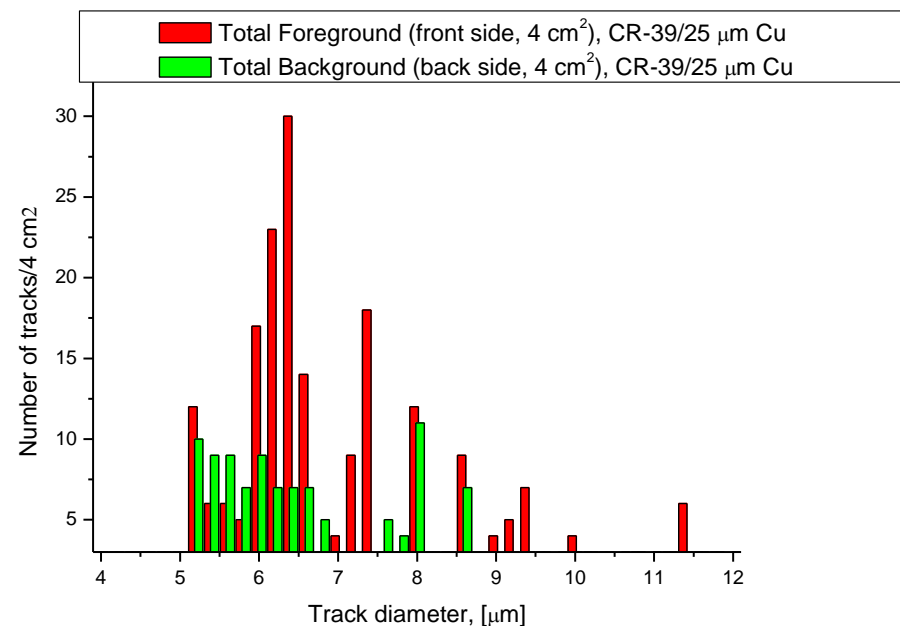
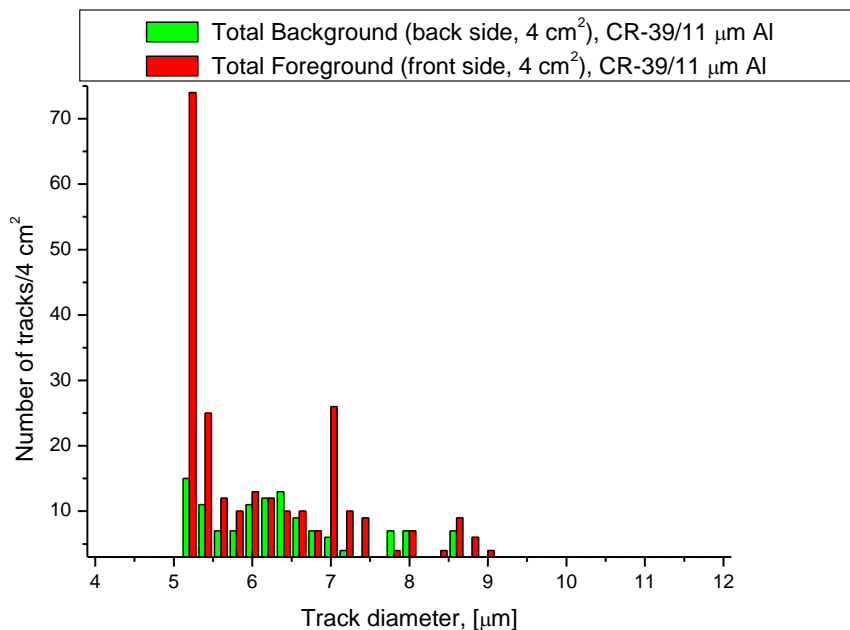

**All Detector Data used with Background subtracted: Sums** for 4 series of runs ( $\Sigma t = 66 \times 50$  min,  $S=4$  cm<sup>2</sup> for #1 and #2): (11 $\mu$ m Al)-left; (25 $\mu$ m Cu)- right; the det. #3-below:  $S=2$  cm<sup>2</sup>,  $t = 1800$  min(33  $\mu$ m Al). Notice shift of 3 MeV proton peak in these 3 detectors

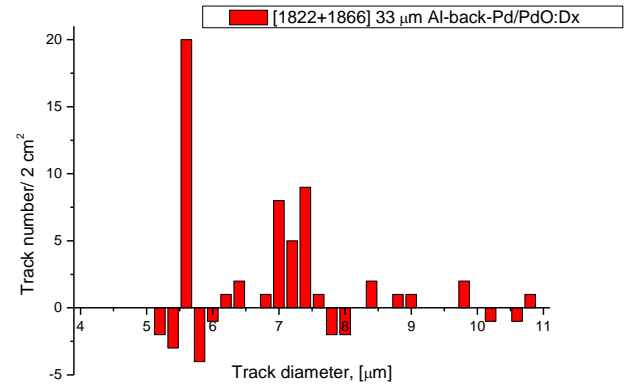
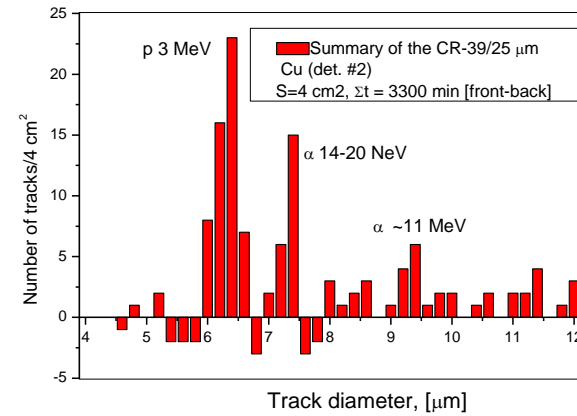
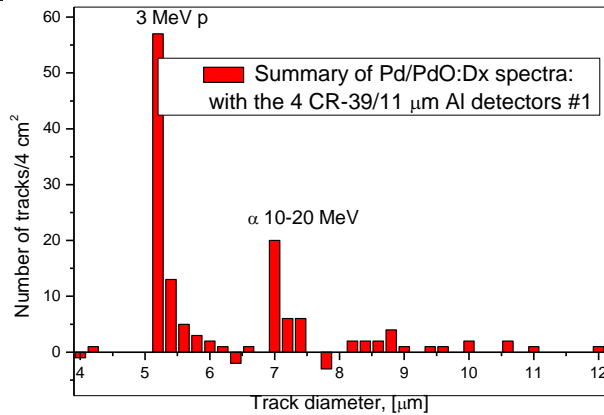

# Charged particle identification by stopping range in Al and Cu foils

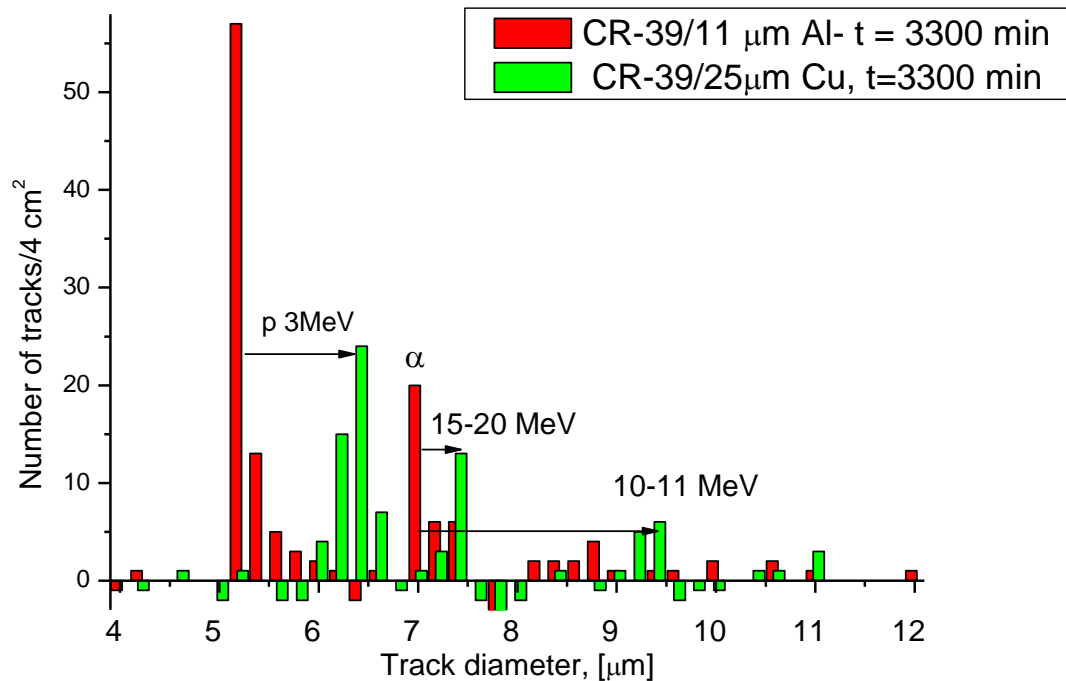

# Comparison of Pd/PdO:Dx and the reference Pd/PdO:Hx runs (detectors 1 and 2) : No effect above the Background is found in the Pd/PdO:Hx runs

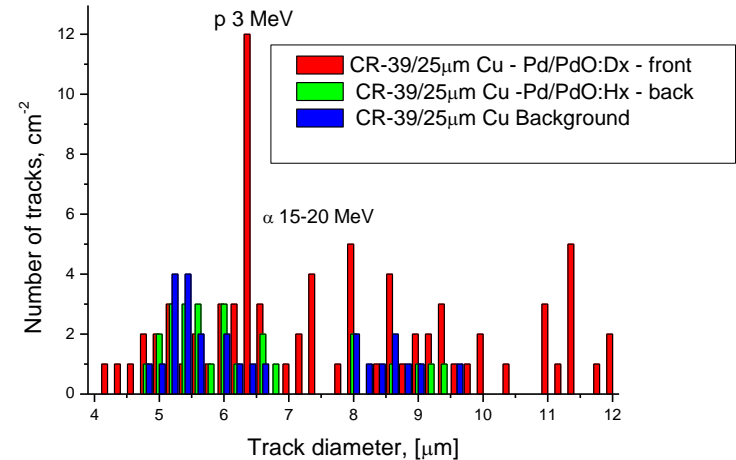
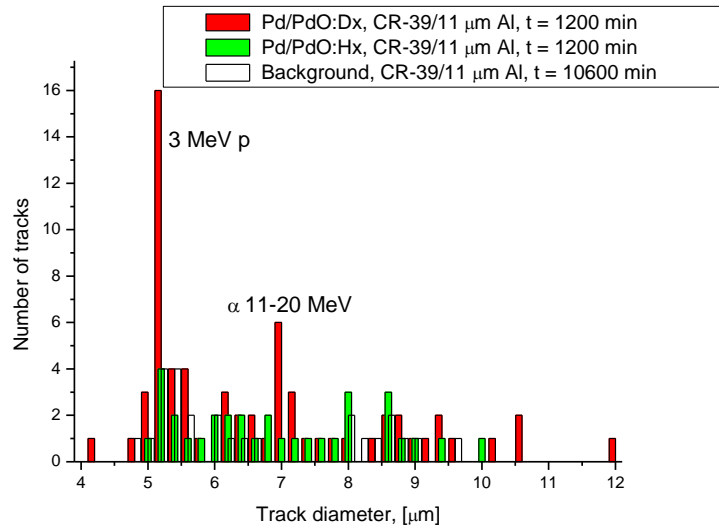

Reproducibility: The number of counts in 3 MeV peak is roughly proportional to the time of detectors 1 and 2.  
Note: the two data points at 3300 minutes are the sum of the data below 1250 minutes.

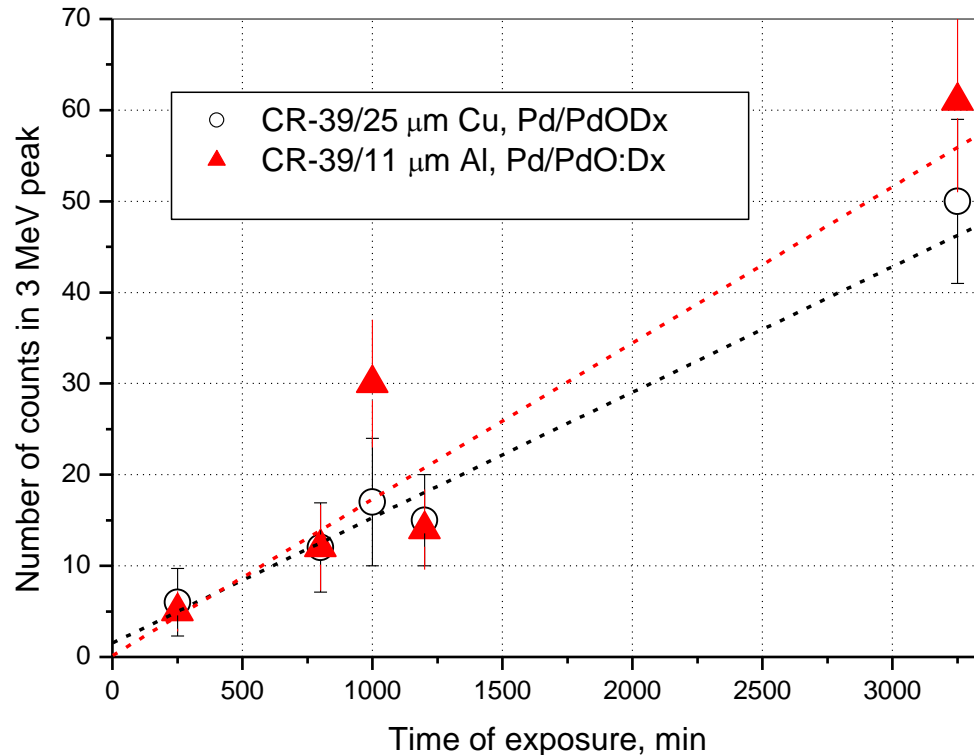

Example detector 1: Two proton tracks of normal 5.2 micron diameter (2) and oblique (1) incidence . The image size is = 120 x 90  $\mu\text{m}^2$ .

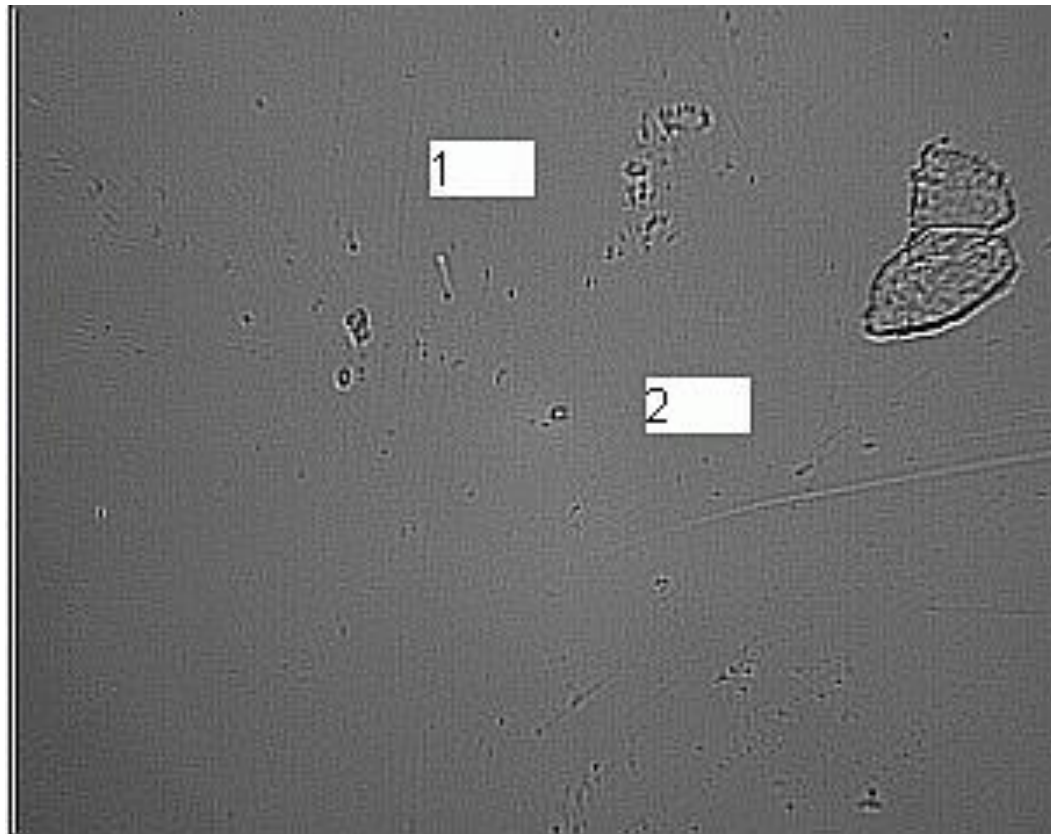

# Landauer CR-39 track diameter vs. charged particle energy (accelerator calibration data). Protons (left) and alphas (right) at normal incidence, various etching times (etching conditions: 6 N NaOH at $t = 70^\circ\text{C}$ )

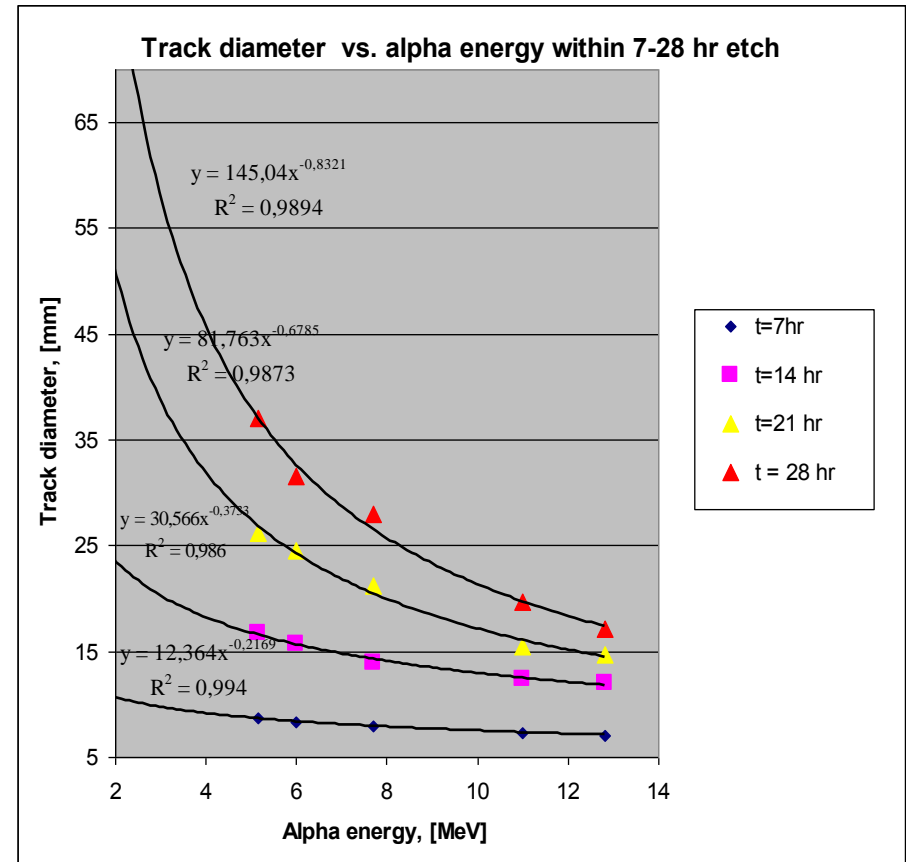
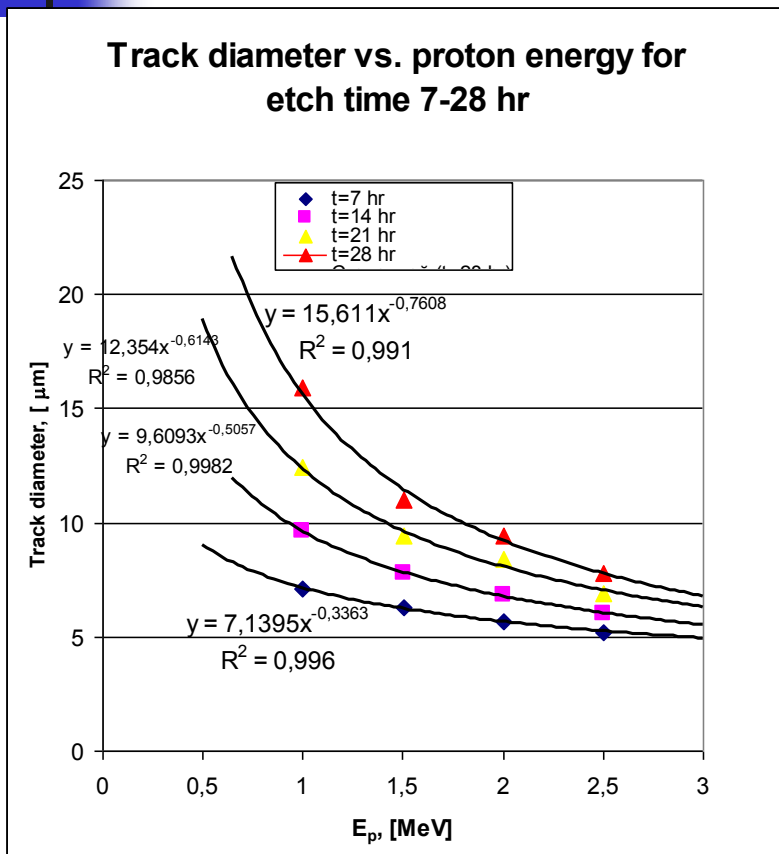



# Sequential Etching of the #1 CR-39/11 $\mu\text{m}$ Al filtered detector

NOTE: Shift of Peaks to Larger Diameters after increased etching time

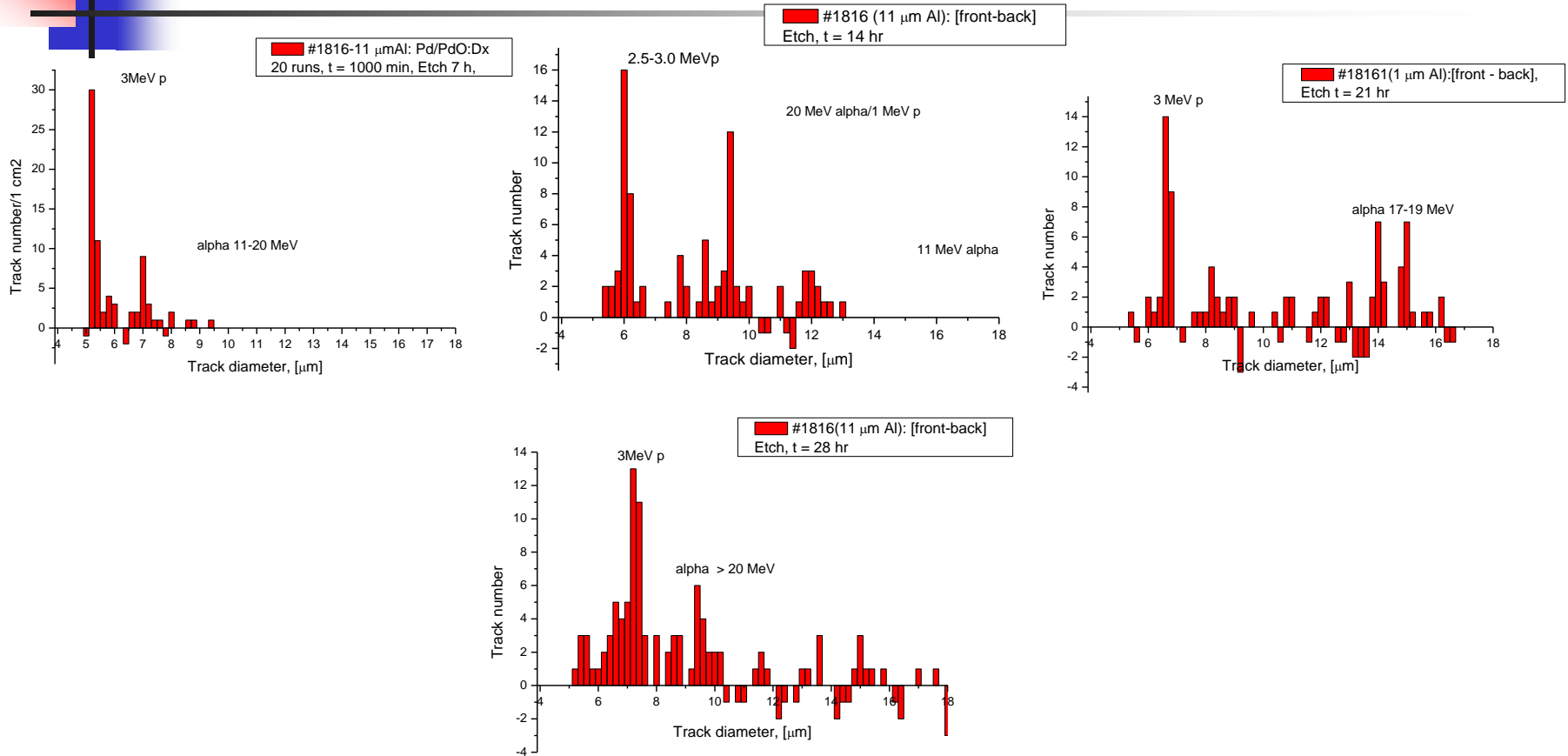

# Differential spectra (with the subtracting of the rear face results) of #1851 CR-39/25 $\mu\text{m}$ Cu filtered detector #2 after its etching during 7 (a), 14(b), 21(c) and 28(d) hr.

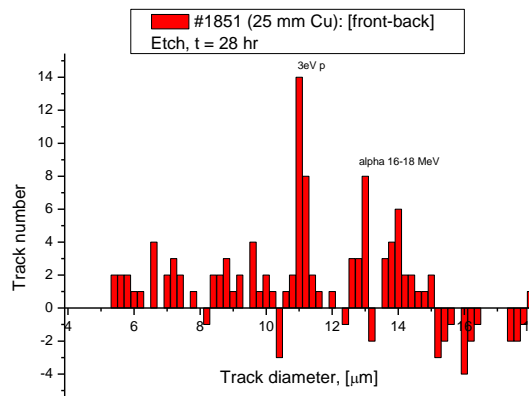
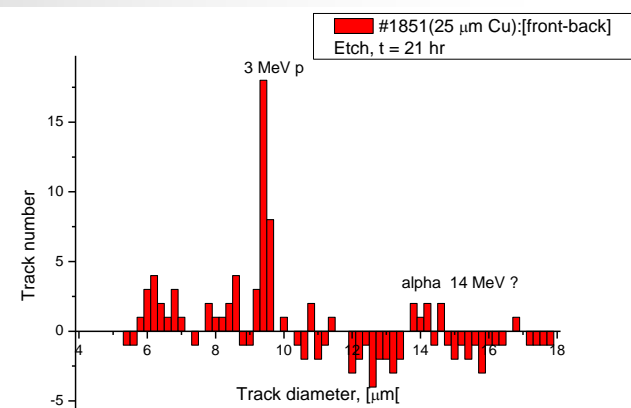
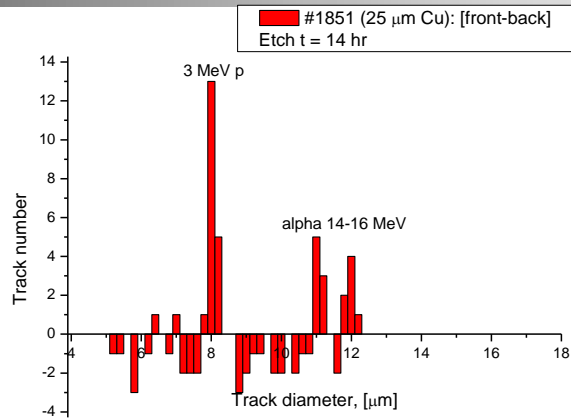
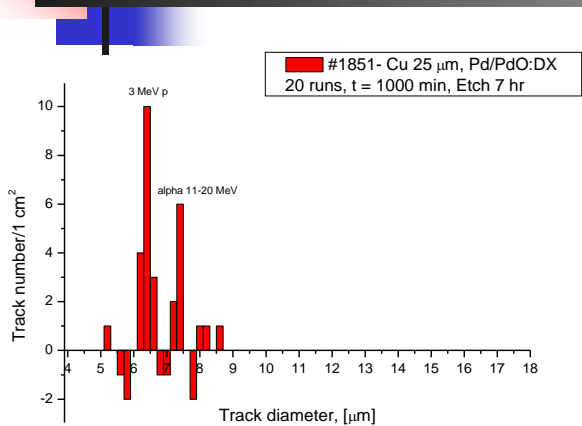

# Track diameter vs. removed depth ( $d(h)$ ) for "proton" tracks Detectors 1 and 2, respectively. NOTE: Consistency of calibration proton and experimental tracks.

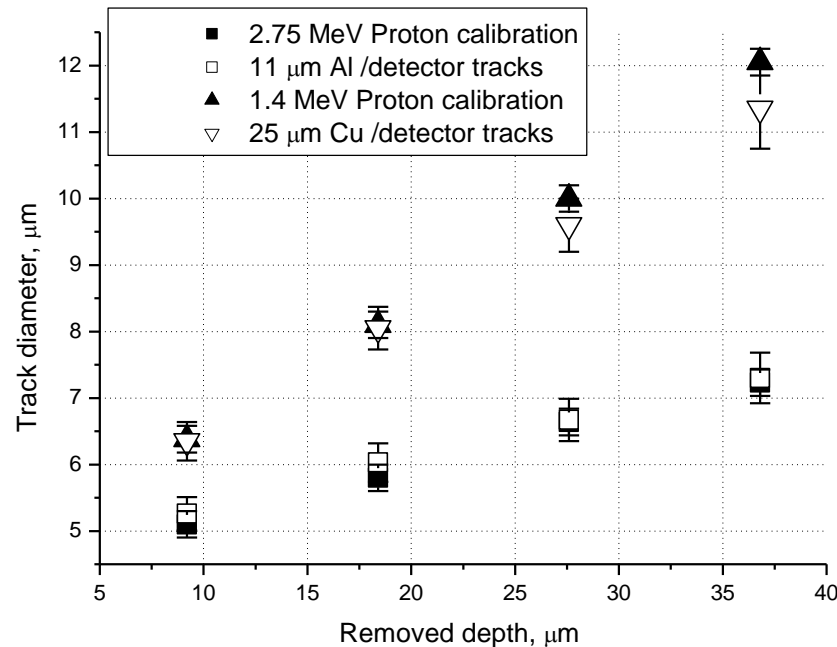

The black squares and triangles represent fit of experimental tracks from detectors 1 and 2 (empty squares and triangles, respectively) with  $d(h)$  functions obtained using normal incidence accelerator CR-39 bombardment at proton energies 2.75 (consistent with 3 MeV proton after its passage through 11  $\mu\text{m}$  thick Al foil) and 1.4 (consistent with to 3 MeV proton after its passage through the 25  $\mu\text{m}$  thick Cu foil) MeV, respectively.

# Track diameter vs. removed depth ( $d(h)$ ) for "alpha" tracks detected during sequential etching of the detectors 1 and 2, respectively.

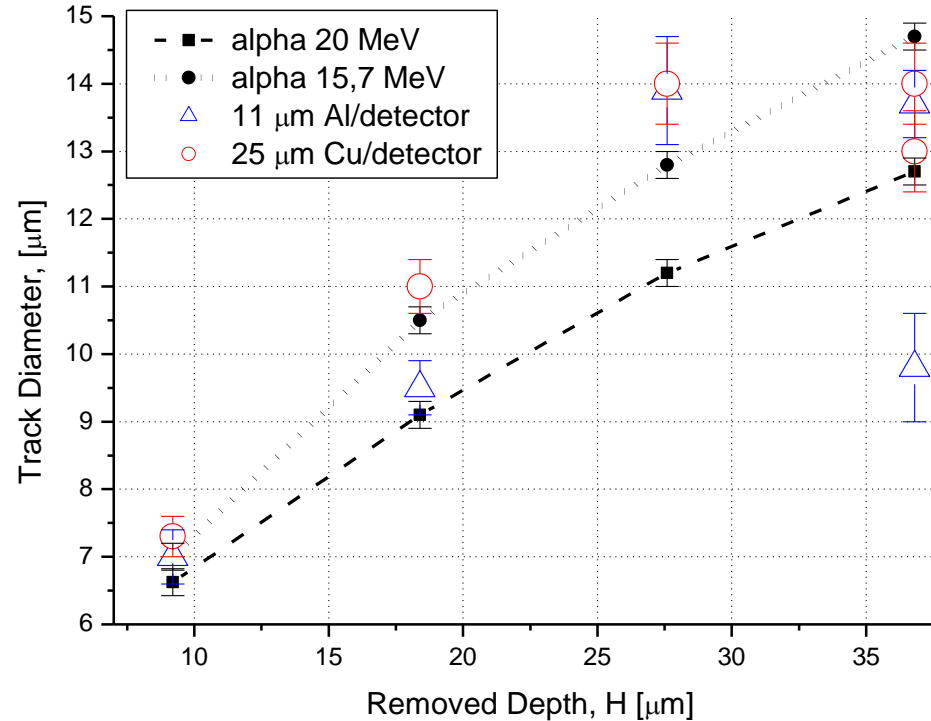

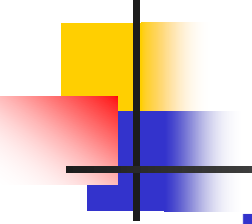

## Averaged of two CR-39 detectors (11 $\mu\text{m}$ All and 25 $\mu\text{m}$ Cu) emission rates for 3 MeV protons and energetic alphas in Pd/PdO:D<sub>x</sub> during 66 runs

- For 3 MeV protons:  $\langle \Delta N_p \rangle = (2.82 \pm 0.29) \times 10^{-4}$  cps/cm<sup>2</sup> of CR-39, with the efficiency of detection ( $\varepsilon = 0.026$ )  $N_p = (1.12 \pm 0.12) \times 10^{-2}$  p/s-cm<sup>2</sup> of the Pd/PdO:D<sub>x</sub> sample (the significance  $L \sim 10.0 \sigma$ ).
- The yield of DD-reaction in the Pd/PdO:D<sub>x</sub> target under e-beam bombardment, taken only for movable deuterons ) is found to be  $\lambda_{DD} \sim 6 \times 10^{-18}$  p/DD-pair (5 orders of magnitude above the "Jones level").
- For 10-20 MeV alphas  $N_\alpha = (0.46 \pm 0.075) \times 10^{-2}$   $\alpha$ /s-cm<sup>2</sup> of the Pd/PdO:D<sub>x</sub> sample, (the significance  $L \sim 6.0 \sigma$ ).
- For the detector placed under the sample (non-irradiated by e-beam side) of the Pd/PdO:D<sub>x</sub> sample:  $N_p = (1.68 \pm 0,37) \times 10^{-3}$  p/s-cm<sup>2</sup> and  $N_\alpha = (1.46 \pm 0.27) \times 10^{-3}$   $\alpha$ /s-cm<sup>2</sup> of the Pd/PdO:D<sub>x</sub> sample or near 1 order of magnitude less than at the irradiated side.

## II. TiDx e-beam stimulation results: total 42 runs of 60 min each: two CR-39 detectors [11 $\mu\text{m}$ Al (left) and 25 $\mu\text{m}$ Cu (right)] with the Background (rear side) subtracted

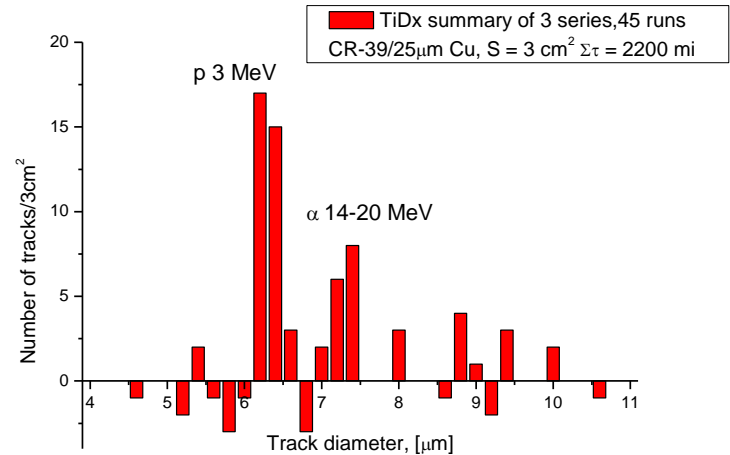
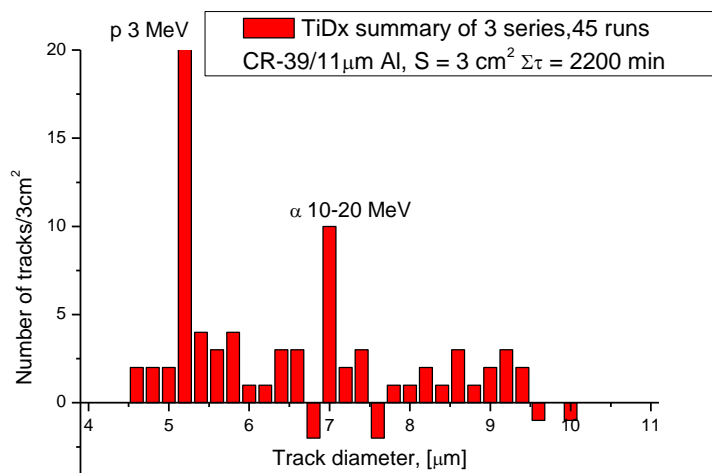

Both statistically significant 3 MeV proton (5.2-5.4  $\mu\text{m}$  track diameter) and 11-20 MeV alphas (7.0-7.6  $\mu\text{m}$  track diameter) bands are appeared in the 11  $\mu\text{m}$  Al covered detector (left); bands of 1.5 MeV protons (track diameter 6.0-6.6  $\mu\text{m}$ , consistent with the 3 MeV proton losses in 25  $\mu\text{m}$  Cu foil) and 14 MeV alphas (track diameter near 7.4  $\mu\text{m}$ , consistent with  $\sim$  17 MeV alpha losses in 25  $\mu\text{m}$  Cu foil are detected (right)

# The Foreground/Background spectra (left) and the differential spectrum (right) of the 33 $\mu\text{m}$ Al covered CR-39 detector placed below the rare (non-irradiated by e-beam) side of the TiDx sample

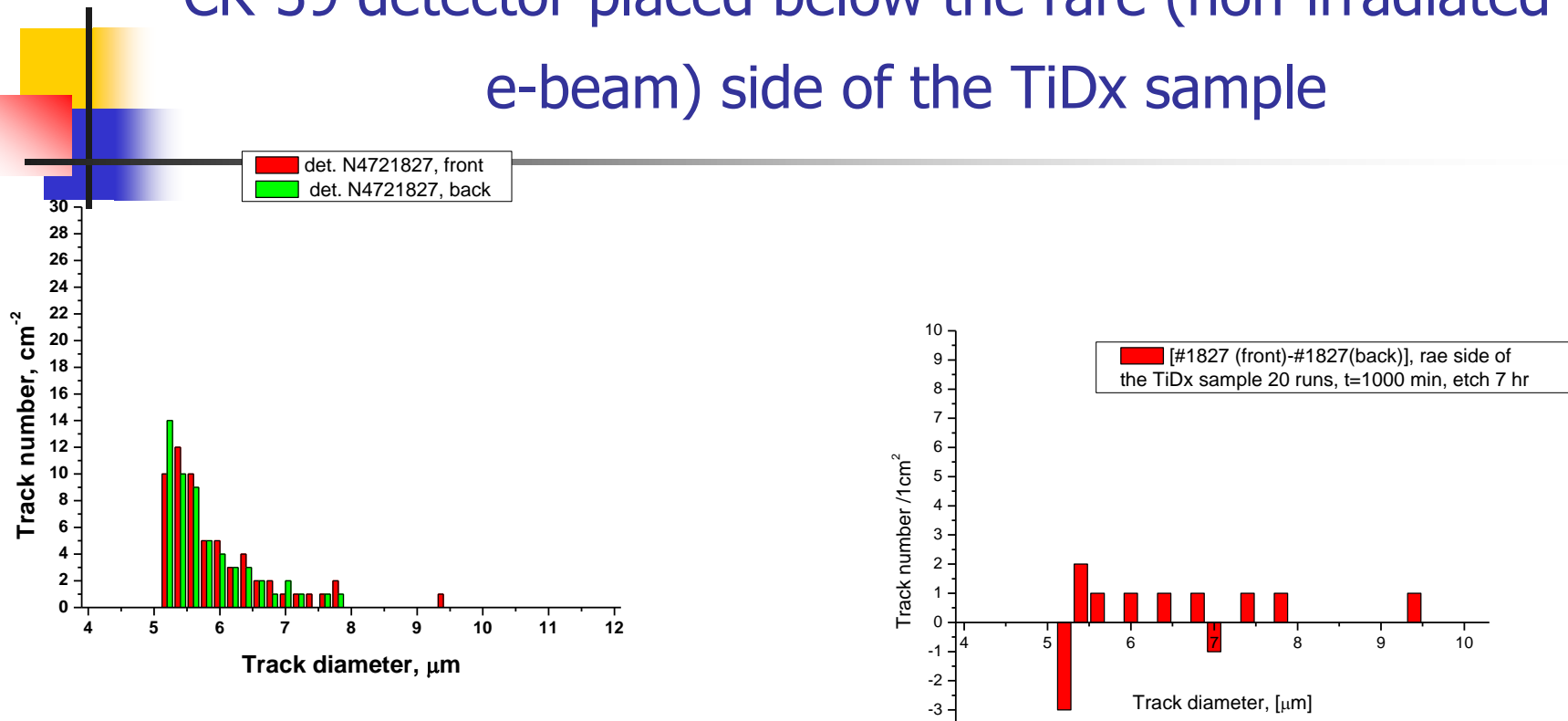

No statistically significant peaks have been found in all differential spectrum (b) from the rear

side of the TiDx sample.



Averaged of two CR-39 detectors (11  $\mu\text{m}$  All and 25  $\mu\text{m}$  Cu) emission rates for 3 MeV protons and energetic alphas in  $\text{TiD}_x$  during 42 runs in 3 series ( $t = 2200$  min)

---

- For 3 MeV protons:  $\langle N_p \rangle = (0.84 \pm 0.15) \times 10^{-2}$  p/s- $\text{cm}^2$  of  $\text{TiD}_x$  sample. (the significance level of the result above the Background is  $L = 5.6 \sigma$ ).
- The yield of DD-reaction in the  $\text{TiD}_x$  target under e-beam bombardment, taken only for movable deuterons ) is found to be  $\lambda_{\text{DD}} \sim 5 \times 10^{-17}$  p/DD-pair (7 orders of magnitude above the "Jones level").
- For 10-20 MeV alphas  $N_\alpha = (0.47 \pm 0.10) \times 10^{-2}$   $\alpha/\text{s-cm}^2$  of the  $\text{TiD}_x$  sample, (the significance is of  $\sim 4.5 \sigma$ ). The soft component of  $\alpha$  ( $E \sim 11$  MeV) is not statistically significant
- The non-irradiated by e-beam face of the  $\text{TiD}_x$  sample show no signatures of nuclear emission.





# Discussion: DD-reaction rate in Pd/PdO:Dx during e-excitation of D-subsystem

---

- To estimate the DD-reaction rate in the Pd/PdO:Dx target under electron bombardment we use a simple model of the process. The desorbed D, stimulated by e-beam, produces a deuterium flux moving toward the Pd/PdO:Dx surface.
- Thus, the moving deuteron flux is a “deuteron beam”, while the deuterated surface of the Pd/PdO sample is the deuterated “target”.
- The deuteron ( $D^+$ ) “current”, estimated via D-desorption rate would be of  $J_d = 0.5 \text{ mA/cm}^2$ , while the mean concentration of deuteron at the surface is the mean D/Pd ratio during e-beam bombardment ( $\langle x \rangle \sim 0.15$  or  $N_d = 1.1 \times 10^{22} \text{ cm}^{-3}$ ).

# Thick target yield in Pd/PdO:Dx under e-beam excitation:

- $I_{DT} = J_d N_{\text{eff}}(T) \times \int_0^{E_d} f(E) \sigma_{DD}(E) (dx/dE) dE$
- Here  $J_d$  – deuteron current density;  $N_{\text{eff}}(T)$  – effective concentration of bounded D in metal at temperature  $T$ , captured at depth  $x$ : ( $N_{\text{eff}}(T) = N_0 \exp(-\varepsilon_d \Delta T / k_B T T_0)$ ), where  $N_0$  – D concentration at  $T_0 = 290$  K;  $f(E)$  – enhancement factor;  $\sigma_{DT}$  – is the bare DT-cross-section;  $dE/dx$  – is the stopping power in target calculated with Monte-Carlo code SRIM (J.F. Ziegler and J.P. Biersack, code SRIM 2003).
- $f(E) = Y_{\text{exp}}(E) / Y_b(E) = \exp[\pi \eta(E) U_e / E]$



## Deuteron screening potential $U_e$ :

---

- $U_e = (T/T_0)^{-1/2} [a \ln(y) + b]$  [A. Lipson et al, High Energy Chem. **42**(4), 319 (2008)] - Empirical equation obtained with the analysis of accelerator data for 70 elements of periodic Table (the data by F. Raiola et al, Europhys. J., **A19**, 283 (2004), see next page)
- where  $a = 145.3$  and  $b=71.2$  – are the numerical constants and  $y = k \times y_0 (J_d/J_0)$ , (here  $k = \exp(-\varepsilon_d \Delta T / k_B T T_0)$   $y_0 = \text{Pd/D}$  at  $T_0 = 290$  K and  $J_0 = 0.03$  mA/cm<sup>2</sup>).
- Substitution of  $J_d = 0.5$  mA/cm<sup>2</sup>,  $T=290$  K and  $\langle \text{Pd/D} \rangle = 6.7$  in eq. for  $U_e$  is resulting in  $U_e = 730 \pm 50$  eV.
- This screening value falls roughly into the interval limited by Kasagi's (600 eV for Pd/PdO) and Raiola's (800 eV for Pd)

Data are taken from F. Raiola et al, Europhys. J., A**19**, 283 (2004). D-bombardment conditions:  $T_0=290\text{K}$ ,  $J_0=0.03\text{mA/cm}^2$ ,  $E_d \geq 5\text{keV}$ .

Points are consistent with increase in  $y = \text{Me/D}$ : Hf, Y, Lu, Sc, Gd, Tm, Ti, Ce, Yb, Sm, Zr, Er, Pr, Eu, Ho, La, Ge, C, W, Sr, Ir, Ba, Ru, Au, Ag, Re, Ni, Nb, Ta, Zn, Bi, Mo, Mn, Mg, Cu, Rh, Fe, Pt, V, Pb, Pd, In, Tl.

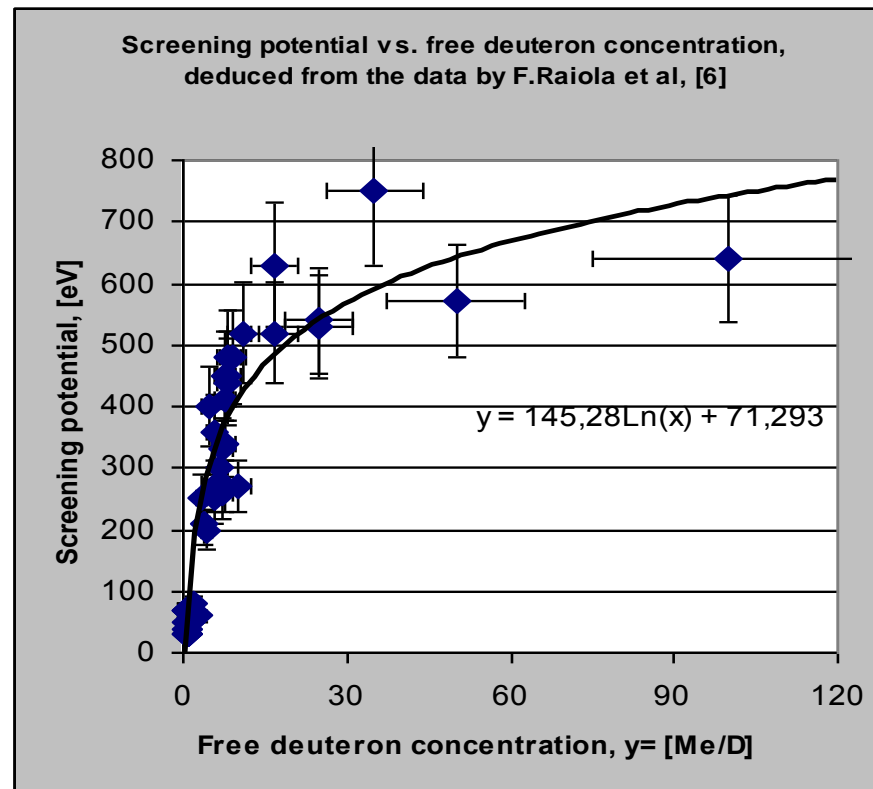

Straight extrapolation of the bare DD-reaction yield (left) and enhancement factor  $f(E)$  (right) to the projectile deuteron energy  $(E_d)_{\text{lab}} = 3.0 \text{ eV}$

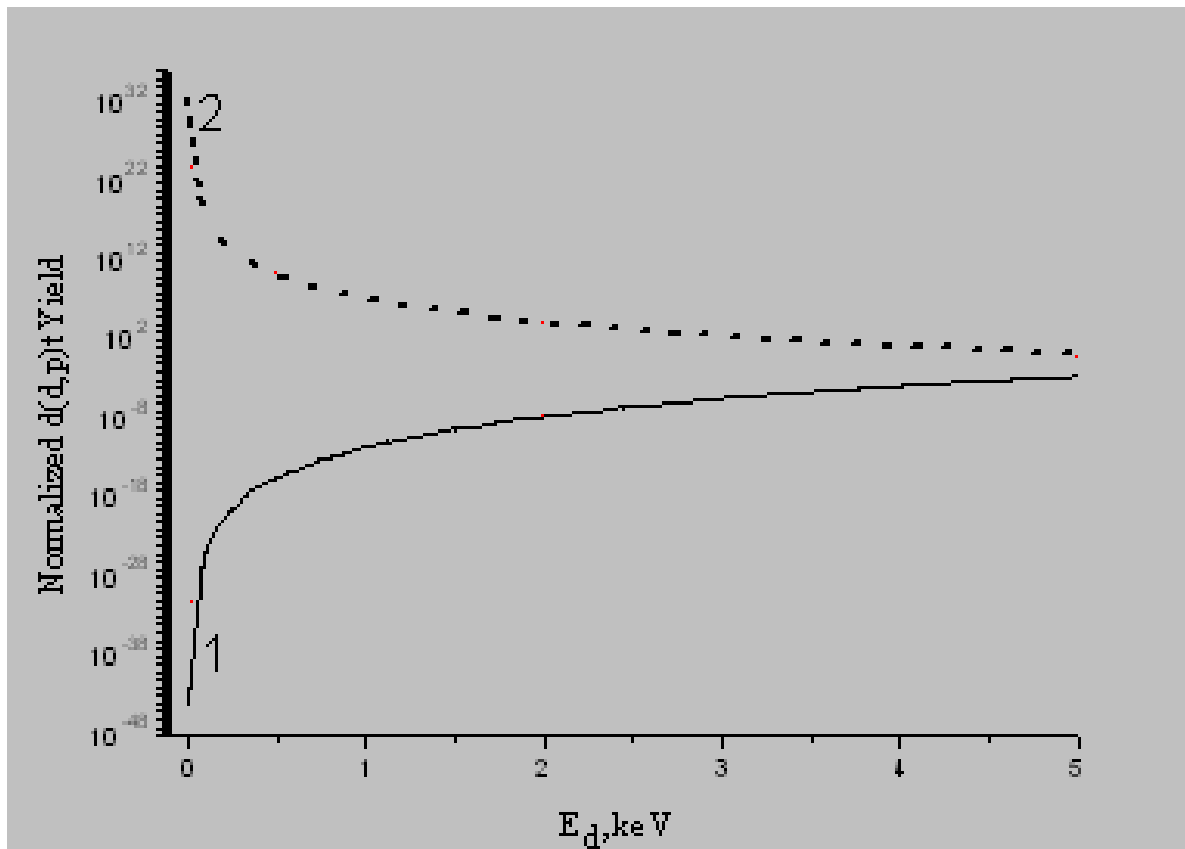

ICCF-15, Rome. Italy 10/5-9,  
2009

## Thick target yield in Pd/PdO:Dx deduced from extrapolation of the bare yield and $f(E)$ to very low $E_d$

- The DD-reaction rate of  $\sim 0.01$  p/s-cm<sup>2</sup> in  $4\pi$  ster. could be reached in the Pd/PdO:Dx target (taking into account  $U_e \sim 730$  eV) only when the mean kinetic energy of the desorbing deuterons is of the order of  $\langle E_d \rangle \sim 3-4$  eV.
- Given mean deuteron energy  $\langle E_d \rangle \sim kT$ , with the same  $U_e$ , the DD-reaction rate would be only  $\sim 10^{-7}$  p/s-cm<sup>2</sup>, or well below our detection limit.
- This result strongly supports the theoretical prediction [V.M., Silkin, I.P Chernov et. al, Phys. Rev., B **76**], 245105 (2007) with regards to electron excitation of hydrogen subsystem in Pd deuteride (hot deuteron generation).
- The 3-4 eV deuteron flux inference suggests a strong electric field ( $F \sim 10^8$  V/cm) generated within a distance compatible with the lattice parameter ( $a_0 = 0.39$  nm) due to plasmon formation during e-beam interaction with the D-subsystem of the Pd/PdO:Dx



## TiD<sub>x</sub> DD-reaction rate

---

- Taking  $J_d = 0.03 \text{ mA/cm}^2$  and  $y_0 \sim 2.0$  (the surface D-concentration is  $x = D/Ti \sim 0.3$  during e-bombardment) one can obtain  $U_e \sim 130 \text{ eV}$
- At this small screening potential, in order to produce DD-reaction rate of the order of  $\sim 0.01 \text{ p/s-cm}^2$ , the kinetic energy of deuteron flux (in laboratory system) has to be rather higher ( $E_d \sim 500 \text{ eV}$ ).
- This high kinetic energy can be gained by D+ acceleration in a strong electric field created by electrostatic charging of the TiO<sub>2</sub> surface with e-beam.
- $(E_d)_{\text{eff}} = \varepsilon_0 + e E(\text{TiO}_2) x h(\text{TiO}_2)$
- At  $\varepsilon_0 \sim 3 \text{ eV}$  (the initial kinetic energy of D+ in Ti caused by plasmon generation),  $E(\text{TiO}_2) \sim 3.5 \times 10^7 \text{ V/cm}$  (electrical strength of TiO<sub>2</sub>) and  $h(\text{TiO}_2) = 1.5 \times 10^{-5} \text{ cm}$ , the  $(E_d)_{\text{max}} \sim 500 \text{ eV}$ !!! suggesting D+ acceleration by a strong electric field during deuteron drift and diffusion through the Ti oxide.

# Conclusions I

- Taking into consideration vacuum experiments with and without e-beam irradiation, we come to the conclusion that electron beam ( $J \sim 100\text{-}300\text{ nA}$ ,  $E = 30\text{ keV}$ ) stimulation of the Pd and Ti deuterided targets (cathodes) surface can enhance the intensity of the emissions of nuclear charged particles.
- Both products of DD-reaction (3 MeV protons) and high energy alphas (11-20 MeV) are clearly seen in e-beam stimulation experiment with the Pd/PdO:Dx and TiDx targets.
- The signatures of 3 MeV protons and energetic alphas appeared simultaneously at the surface of all (#1, #2 and #3) independent detectors used in the same experiment.





## Conclusions II

---

- Data analysis has been performed for Pd/PdO:Dx target. Extrapolation of both DD-reaction cross section and the enhancement factor to very low deuteron energy ( $E_d \sim 3.0$  eV) with a reasonable screening potential  $U_e = 730$  eV, can satisfactorily account for the the detected DD-reaction rate in Pd/PdO:Dx target under e-beam excitation. This result strongly supports the theoretical prediction with regards to electron excitation of hydrogen subsystem in Pd deuteride.
- In order to enhance charged particle yield, we plan to vary target deuteron loading and the current and energy of the electron beam. We will seek to optimize nuclear yields.
- More work also should be done with respect to the energy spectra characterization and the origin of the energetic alpha emission. Electronic detectors have significant noise problems that challenge our ingenuity in these experiments.



# Acknowledgements

---

- The assistance and support of our colleagues David Knies, Graham Hubler, Ken Grabowski at NRL and Peter Hagelstein at MIT are much appreciated.